

Luna Analytical



Luna Precision



# Luna

## LAB, LPB, LTB, LBB, LBL Series

# Operating Manual

For internal ('i') and external ('e') calibration models

Software rev.: V1.0105 & above (Analytical Models)  
V2.0104 & above (Precision Models)

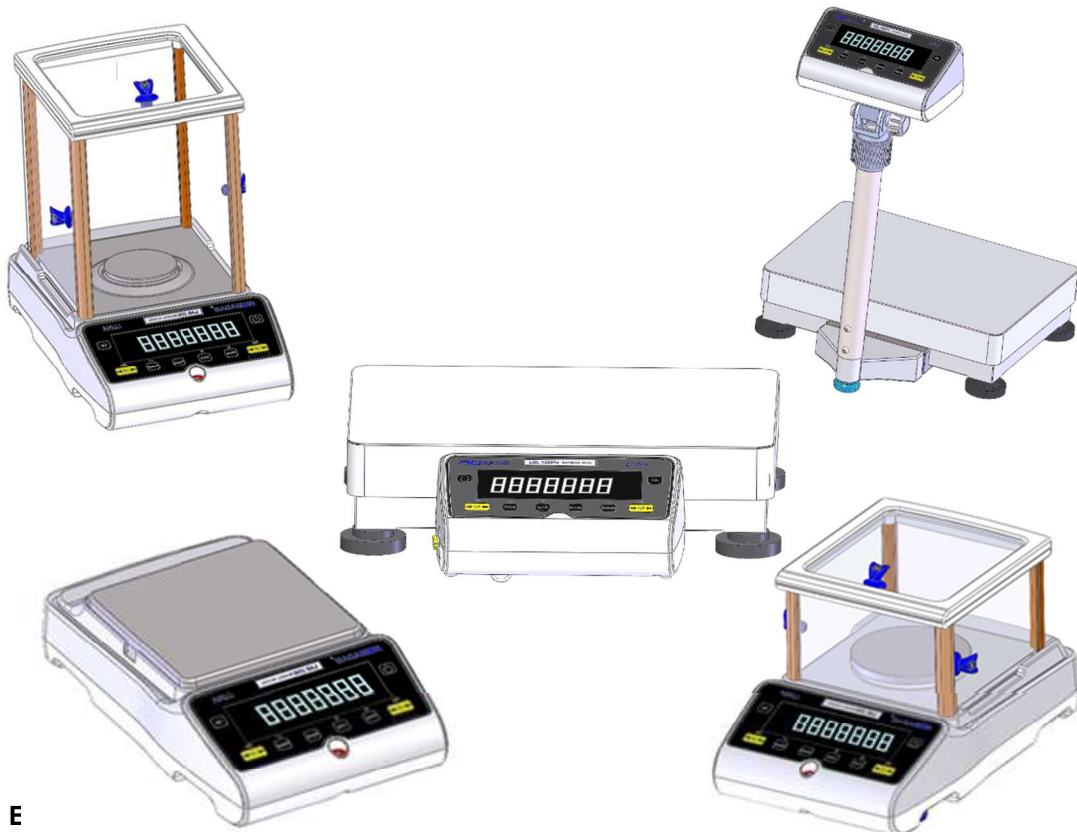

**TABLE OF CONTENTS**  
**P.N. 3016615314, Rev 4a, Jan 2024**

1.0	KNOW YOUR BALANCE .....	3
2.0	PRODUCT OVERVIEW .....	4
3.0	PRODUCT SPECIFICATIONS .....	5
4.0	UNPACKING THE BALANCE .....	11
5.0	LOCATING THE BALANCE .....	11
6.0	SETTING UP THE BALANCE .....	12
6.1	ASSEMBLING THE BALANCE .....	12
6.1.1	<i>Levelling the balance</i> .....	12
6.1.2	<i>Warm-Up Time</i> .....	12
6.1.3	<i>Weighing</i> .....	12
6.2	CALIBRATION .....	13
6.2.1	<i>External Calibration</i> .....	13
6.2.2	<i>Motorised Internal Calibration</i> .....	13
6.2.3	<i>Calibration Errors</i> .....	13
7.0	DISPLAY .....	14
7.1	SYMBOLS AND TEXT .....	14
8.0	KEYPAD .....	15
8.1	NUMERIC ENTRY METHOD .....	16
9	INPUT/OUTPUT .....	16
10.0	OPERATIONS .....	17
10.1	INITIALISATION .....	17
10.2	PASSCODES .....	17
10.3	WEIGHING .....	18
10.4	FUNCTIONS .....	19
10.4.1	<i>Parts Counting</i> .....	20
10.4.2	<i>Percentage Weighing</i> .....	20
10.4.3	<i>Check weighing</i> .....	21
10.4.4	<i>Animal (Dynamic) Weighing</i> .....	22
10.4.5	<b>Net / Total</b> .....	24
10.4.6	<i>Density Determination</i> .....	24
11.0	RS-232 INTERFACE .....	26
11.1	HARDWARE .....	26
11.2	OUTPUT FORMATS .....	26
11.2.1	<i>Single-line output format</i> .....	26
11.2.2	<i>Custom output format</i> .....	28
11.3	INPUT COMMANDS USING REMOTE KEYS .....	29
11.3.1	<i>Invalid input command:</i> .....	29
12.0	RJ45 NETWORK INTERFACE .....	30
12.1	OVERVIEW .....	30
12.2	CONNECTING .....	31
12.3	OUTPUT FORMAT AND REMOTE INSTRUCTIONS .....	31
13.0	ERROR CHECKING .....	32
14.0	SUPERVISOR MENUS .....	33
14.1	ENABLE WEIGHING UNITS .....	33
14.2	ENABLE WEIGHING MODES .....	33
14.3	ENABLE SERIAL INTERFACE PARAMETERS .....	33
14.4	FORMAT OF CUSTOM FORMS #1 and #2 .....	34
14.5	SETUP PARAMETERS .....	35
14.6	CALIBRATION SETUP .....	36

14.7 PASSCODES .....	36
15.0 ACCESSORIES & SPARE PARTS .....	37
16.0 SAFETY AND MAINTENANCE .....	38
17.0 TROUBLE-SHOOTING .....	39
17.1 TROUBLE-SHOOTING GUIDE .....	40
18.0 SERVICE INFORMATION.....	42
19.0 BALANCE MENU STRUCTURE .....	43
20.0 LANGUAGE TABLE .....	46
21.0 WARRANTY INFORMATION.....	47

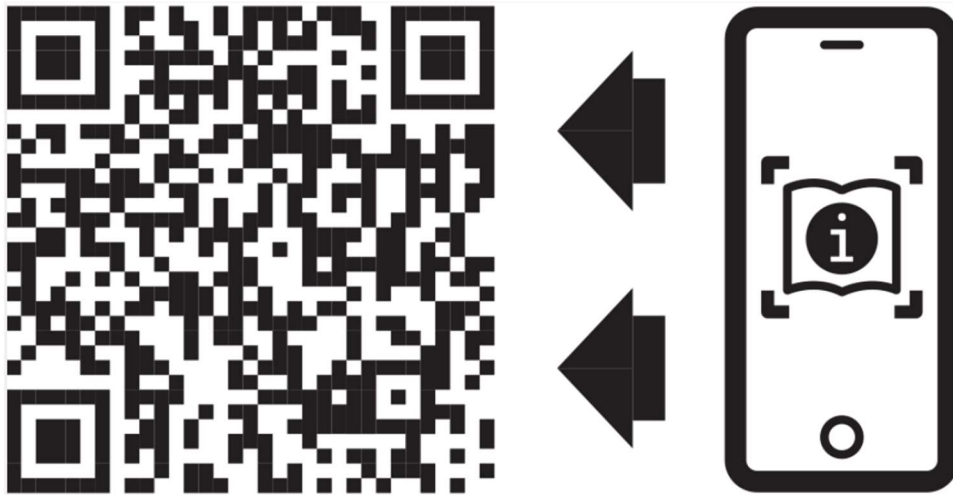

## **1.0 KNOW YOUR BALANCE**

Thank you for selecting the Luna Balance from Adam Equipment.

This Instruction Manual will familiarise you with the installation, use, general maintenance etc. of the balance, and will guide you through the various applications. It also covers accessories, trouble-shooting, after sales service information, and other important information.

These balances are highly accurate precision instruments and contain sensitive mechanisms and components. They should be transported and handled with care. When in operation, be careful to place loads gently on the weighing surface and do not overload or exceed recommended maximum capacity of the instrument or damage may occur.

Please read this Manual thoroughly before starting operation. If you need any clarifications, feel free to contact your supplier or Adam Equipment.

## 2.0 PRODUCT OVERVIEW

The Luna balances are ideal for laboratory and general purpose weighing. They can also be used for some advanced weighing functions.

### FEATURES:

- External menu-driven calibration allowing user-selectable range of calibration weights.
- Internal calibration (option) for outstanding accuracy without the need for manual calibration.
- Mains powered.
- Wipe clean ABS plastic housing with 304 grade stainless steel pan.
- Large easy to read dual line LCD display with backlight.
- Standard applications include weighing, percentage weighing, parts counting, dynamic (animal) weighing and solid and liquid density determination.
- Bi-directional RS-232 interface and USB interface as standard. RJ45 network interface is standard for LBL series.
- Can be configured to print a GLP Compliant report after each calibration to include the time, date, balance number and a verification of the calibration.
- Force-restoration mechanism for supreme accuracy, or alloy load cell technology for stable yet accurate weighing.
- Automatic temperature compensation.
- Multiple weighing units.
- Easy to use, wipe-clean sealed membrane keypad.
- Below balance weighing facility (accessory hook required).
- Display in a choice of 4 languages – English, German, French & Spanish.
- Password protection.
- Security locking point.

### 3.0 PRODUCT SPECIFICATIONS

#### Luna Models

(Suffix e for external calibration models, Suffix i for internal calibration models)

#### ANALYTICAL BALANCES LAB

Model #	LAB 84 e/i	LAB 124 e/i	LAB 214 e/i	LAB 254 e/i
Maximum Capacity	80 g	120 g	210 g	250 g
Readability (d)	0.0001 g	0.0001 g	0.0001 g	0.0001 g
Number of intervals n=	800000	1200000	2100000	2500000
Min. weight (USP)	0.4 g	0.4 g	0.4 g	0.4 g
Repeatability (Std. Dev)	0.0002 g	0.0002 g	0.0002 g	0.0002 g
Linearity $\pm$	0.0003 g	0.0003 g	0.0003 g	0.0003 g
Units of Measure	grams, milligrams, carats, grains, Newtons, ounces, troy ounces, Drams, Taels-HK, Taels-T, Taels-S, Mommies, Tolas, Ticals, pennyweight, custom			
Stabilization Time	Typically 3 seconds			
Operating Temp	15°C to 35°C recommended, 40 – 60 % RH (non-condensing)			
Power Supply	External mains power adapter - supplied as standard (Input Voltage 100–240 VAC, 50/60 Hz)			
Input Voltage	18 VDC - 830 mA			
Weighing mechanism	Force Restoration			
Calibration	Suffix i = internal calibration mechanism, e = external calibration only			
External Calibration Mass	Recommended OIML class: E2, ASTM / ANSI class: 1			
	50 g	100 g	100 g	100 g
Display	LCD with black backlight, 7 characters, 24 mm high, and symbols			
Draft Shield (w x d x h)	Sliding door Draft Shield (198 x 212 x 240 mm)			
Pan Size	Round, <b>80mm</b> diameter			
Overall Dimensions (w x d x h)	228 x 377 x 333 mm 9 x 14.8 x 13.1 in			
Net Weight	e models	5.9 kg / 13 lb 0 oz		
	i models	6.2 kg / 13 lb 10 oz		

## PRECISION BALANCES LPB

Model #	LPB 223 e / i	LPB 423 e / i
Maximum Capacity	220 g	420 g
Readability (d)	0.001 g	
Number of intervals n=	220000	420000
Min. weight (USP)	4 g	4 g
Repeatability (Std. Dev)	0.002 g	
Linearity ±	0.003 g	
Units of Measure	Kilograms, grams, milligrams, carats, grains, Newtons, pounds, ounces, troy ounces, Drams, Taels-HK, Taels-T, Taels-S, Mommies, Tolas, Ticals, pennyweight, custom	
Stabilization Time	Typically 3 seconds	
Operating Temp	15°C to 35°C recommended, 40 – 60 % RH (non-condensing)	
Power Supply	External mains power adapter - supplied as standard (Input Voltage 100–240 VAC, 50/60 Hz) [Removed text related to battery].	
Input Voltage	18 VDC - 830 mA	
Weighing mechanism	Precision Load Cell	
Calibration	Suffix i = internal calibration mechanism, e = external calibration only,	
External Calibration Mass	Recommended OIML class: E2, ASTM / ANSI class: 2	
	50, 100, 200 g	100, 200, 400 g
Display	LCD with black backlight, 7 characters, 24 mm high, and symbols	
Draft Shield (w x d x h)	Sliding door Draft Shield (198 x 212 x 120 mm)	
Pan Size	Round, 120 mm diameter	
Overall Dimensions (w x d x h)	228 x 377 x 213 mm 9 x 14.8 x 8.4 in	
Net Weight	e models	4.3 kg / 9 lb 8 oz
	i models	4.7 kg / 10 lb 5.7 oz
		4.3 kg / 9 lb 8 oz
		4.9 kg / 10 lb 12.8 oz

## **PRECISION BALANCES LPB**

<b>Model #</b>	<b>LPB 623 e / i</b>	<b>LPB 823 e / i</b>
Maximum Capacity	620 g	820 g
Readability (d)	0.001 g	
Number of intervals n=	620000	820000
Min. weight (USP)	4 g	4 g
Repeatability (Std. Dev)	0.002 g	
Linearity $\pm$	0.003 g	
Units of Measure	Kilograms, grams, milligrams, pounds, carats, grains, Newtons, pounds, ounces, troy ounces, Drams, Taels-HK, Taels-T, Taels-S, Mommies, Tolas, Ticals, pennyweight, custom	
Stabilization Time	Typically 3 seconds	
Operating Temp	15°C to 35°C recommended, 40 – 60 % RH (non-condensing)	
Power Supply	External mains power adapter - supplied as standard (Input Voltage 100–240 VAC, 50/60 Hz)	
Input Voltage	18 VDC - 830 mA	
Weighing mechanism	Force Restoration	
Calibration	Suffix i = internal calibration mechanism, e = external calibration only	
External Calibration Mass	Recommended OIML class: E2, ASTM / ANSI class: 2	
	500 g	
Display	LCD with black backlight, 7 characters, 24 mm high, and symbols	
Draft Shield (w x d x h)	Sliding door Draft Shield (198 x 212 x 120 mm)	
Pan Size	Round, 120 mm diameter	
Overall Dimensions (w x d x h)	228 x 377 x 213 mm 9 x 14.8 x 8.4 in	
Net Weight	e models	5.9 kg / 13 lb 0 oz
	i models	6.4 kg / 14 lb 1.6 oz
		5.9 kg / 13 lb 0 oz
		6.6 kg / 14 lb 8.8 oz



## **PRECISION BALANCES LTB**

<b>Model #</b>	<b>LTB 2602 e / i</b>	<b>LTB 3602 e / i</b>	<b>LTB 4602 e / i</b>	<b>LTB 6002 e / i</b>
Maximum Capacity	2600 g	3600 g	4600 g	6000 g
Readability (d)	0.01 g	0.01 g	0.01 g	0.01 g
Number of intervals n=	260000	360000	460000	600000
Min. weight (USP)	40 g	40 g	40 g	40 g
Repeatability (Std. Dev)	0.02 g			
Linearity ±	0.03 g			
Units of Measure	Kilograms, grams, milligrams, carats, grains, Newtons, pounds, ounces, troy ounces, Drams, Taels-HK, Taels-T, Taels-S, Mommies, Tolas, Ticals, pennyweight, custom			
Stabilization Time	Typically 3 seconds			
Operating Temp	15°C to 35°C recommended, 40 – 60 % RH (non-condensing)			
Power Supply	External mains power adapter - supplied as standard (Input Voltage 100–240 VAC, 50/60 Hz)			
Input Voltage	18 VDC - 830 mA			
Weighing mechanism	Precision Load Cell			
Calibration	Suffix i = internal calibration mechanism, e = external calibration only			
External Calibration Mass	Recommended OIML class: F1, ASTM / ANSI class: 3			
	0.5, 1, 2 kg	1, 2, 3 kg	1, 2, 4 kg	1, 2, 5 kg
Display	LCD with black backlight, 7 characters, 24 mm high, and symbols			
Draft Shield (w x d x h)	None			
Pan Size	Square, 185x185 mm			
Overall Dimensions (w x d x h)	228 x 337 x 108 mm 9 x 14.8 x 4.3 in			
Net Weight	e models	3.6 kg / 7 lb 14.8 oz		
	i models	4.6 kg / 10 lb 2.2 oz	4.8 kg / 10 lb 9.3 oz	5.0 kg / 11 lb 0 oz

## **PRECISION BALANCES LBB**

<b>Model #</b>	<b>LBB 6001e</b>	<b>LBB 8001e</b>	<b>LBB 12001e</b>	<b>LBB 15001e</b>
Maximum Capacity	6000g	8000g	12000g	15000g
Readability (d)	0.1g	0.1g	0.1g	0.1g
Number of intervals n=	60000	80000	120000	150000
Min. weight (USP)	400 g	400 g	400 g	400 g
Repeatability (Std. Dev)	0.2g			
Linearity ±	0.3g			
Units of Measure	Kilograms, grams, milligrams, carats, grains, Newtons, pounds, ounces, troy ounces, Drams, Taels-HK, Taels-T, Taels-S, Mommies, Tolas, Ticals, pennyweight, custom			
Stabilization Time	Typically 3 seconds			
Operating Temp	15°C to 35°C recommended, 40 – 60 % RH (non-condensing)			
Power Supply	External mains power adapter - supplied as standard (Input Voltage 100–240 VAC, 50/60 Hz) [Removed text related to battery]			
Input Voltage	18 VDC - 830 mA			
Weighing mechanism	Precision Load Cell			
Calibration	External calibration only			
External Calibration Mass	Recommended OIML class: F2, ASTM / ANSI class: 4			
	1, 2, 5 kg	2, 5, 8 kg	2,5, 10 kg	5,10, 15 kg
Display	LCD with blue backlight, 7 characters, 24 mm high, and symbols			
Draft Shield (w x d x h)	None			
Pan Size	Square, 185x185 mm			
Overall Dimensions (w x d x h)	228 x 337 x 108 mm 9 x 14.8 x 4.3 in			
Net Weight	3.7 kg / 8 lb 2.4 oz			

## **HEAVY DUTY BALANCES LPB [with or without Pillar]**

**Suffix p denotes pillar model**

<b>Model #</b>	LBL14001[p]	LBL24001[p]	LBL34001[p]
Maximum Capacity	14kg	24kg	34kg
Readability (d)	0.1g	0.1g	0.1g
Number of intervals n=	140000	240000	340000
Min. weight (USP)	400g	400g	400g
Repeatability (Std. Dev)	0.2g		
Linearity $\pm$	0.4g		
Units of Measure	Kilograms,grams, milligrams, carats, grains, Newtons, pounds,ounces, Pound Ounce ,troy ounces, Taels-T, pennyweight, custom		
Stabilization Time	Typically 3 seconds		
Operating Temp	15°C to 35°C recommended, 40 – 60 % RH (non-condensing)		
Power Supply	External mains power adapter - supplied as standard 100–240 VAC, 50/60 Hz Internal lithium battery pack—optional (battery :12V 2800mA lithium battery)		
Input Voltage	12.6VDC - 1000mA		
Weighing mechanism	Precision Load Cell		
Calibration	External calibration only		
External Calibration Mass	Recommended OIML class: F2, ASTM / ANSI class: 4		
	5,10,15 kg	10,20,25 kg	10,20,35 kg
Display	LCD with black backlight, 7 characters, 24 mm high, and symbols		
Draft Shield (w x d x h)	None		
Pan Size	square, 400x300mm		
Overall Dimensions (w x d x h)	400x430x200 mm 400x440x580mm with Pillar		
Net Weight	7.3kg / 8.3Kg with Pillar		

## 4.0 UNPACKING THE BALANCE

Remove the balance from the packing by carefully lifting it out of the box. Inside the box you will find everything needed to start using the balance-

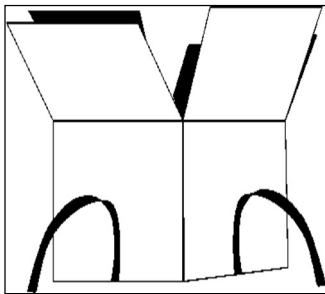

- AC mains power adapter & cord
- Stainless Steel Top Pan
- Alloy sub-pan
- User documentation

Carefully follow the quick setup guide included to assemble the balance.

## 5.0 LOCATING THE BALANCE

	<p>The balance should not be placed in a location that will reduce the accuracy.</p> <p>Avoid extremes of temperature. Do not place in direct sunlight or near air conditioning vents.</p>
	<p>Avoid unsuitable tables. The table or floor must be rigid and not vibrate.</p> <p>Avoid unstable power sources. Do not use near large users of electricity such as welding equipment or large motors.</p>
	<p>Do not place near vibrating machinery.</p> <p>Avoid high humidity that might cause condensation. Avoid direct contact with water. Do not spray or immerse the balances in water.</p> <p>Avoid air movement such as from fans or opening doors. Do not place near open windows or air-conditioning vents.</p>
	<p>Keep the balance clean. Do not stack material on the balances when they are not in use.</p> <p>Avoid sources of static electricity. This can affect measurement accuracy and may damage sensitive electronics.</p>

## 6.0 SETTING UP THE BALANCE

### 6.1 ASSEMBLING THE BALANCE

Carefully follow the below guide to assemble the balance. Ensure that you locate the balance on a solid level surface, free from vibration.

#### 6.1.1 Levelling the balance

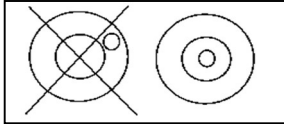

After placing the balance in a suitable location, level it by using the spirit level on the front of the balance. To level the balance turn the two adjustable feet at the front of the balance until the bubble in the spirit level is centred.

#### 6.1.2 Warm-Up Time

Before you start weighing, you should allow the balance to achieve a stable internal temperature. LBL models should be warmed up for at least 2 hours. For accurate weighing to the manufacturer's specification it is important to power on the balance and allow to warm up for at least 6 hours for LBB + LTB models, and 12 hours for LAB + LPB models.

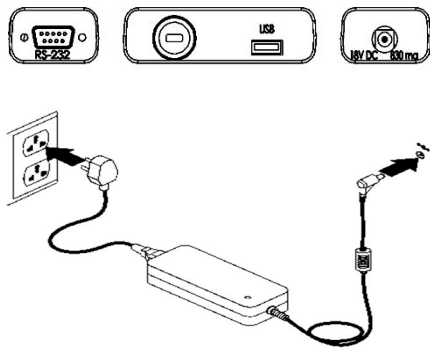

Insert the power supply cable DC connector to the connector on the rear of the balance. Plug the power supply module into the mains and press the power switch on the keypad to turn on the balance. The display will indicate the balance serial number followed by the software revision number, followed by the maximum capacity of the balance. Next the balance will run a self-test by displaying all segments followed by a busy symbol and a line of 7 dashes indicating the balance is in busy mode. Once ready, the display will show a zero weight reading, accompanied by the →0← symbol.

#### 6.1.3 Weighing



Once a suitable warm-up period is complete and you are ready to start weighing, place an item to be weighed on the balance. A stable symbol ∞ is shown when the balance is in stable condition. It will turn off if the balance is not stable.

Exact zero is shown when the "→0←" symbol is visible on the top left of the display area. [display photo changed]

## 6.2 CALIBRATION

Units with an 'i' suffix can be calibrated using either internal calibration mechanism or by using an external mass. Units with an 'e' suffix can only be calibrated with an external mass. Internal calibration option must be enabled in the setup menu options or else external calibration mode will be used when the **[Cal]** key is pressed.

### 6.2.1 External Calibration

- Pressing the **[Cal]**
- Display shows: "LOAD 0 g"
- Press the **[Setup]**
- Display shows: "-----"
- For analytical and LPB623 and LPB823 models, the display shows an appropriate weight for your model, load the weight.
- For precision models, then display shows "CHOOSE g", press **[Unit]** or **[Cal]** to select calibration weight value, and then press the **[Setup]**, display shows "LOAD xxxx g", load the weight.
- Display shows: "-----"
- Display shows: "UNLOAD", remove the weight and clear the top pan.
- Display shows: "-----", then returns to zero. The calibration is complete.

### 6.2.2 Motorised Internal Calibration

If your balance is fitted with internal calibration (i models), then press **[Cal]** and the balance will automatically run through the above processes and finish calibration.

### 6.2.3 Calibration Errors

Occasionally during calibration an error will be detected. These errors can be caused by:

- Unstable readings
- Improper calibration weights being used
- Large shifts of zero from the factory settings

When an error is found a displayed message will be shown and the calibration must be done again. If the balance has error messages more than once it is possible the mechanics have been damaged.

## 7.0 DISPLAY

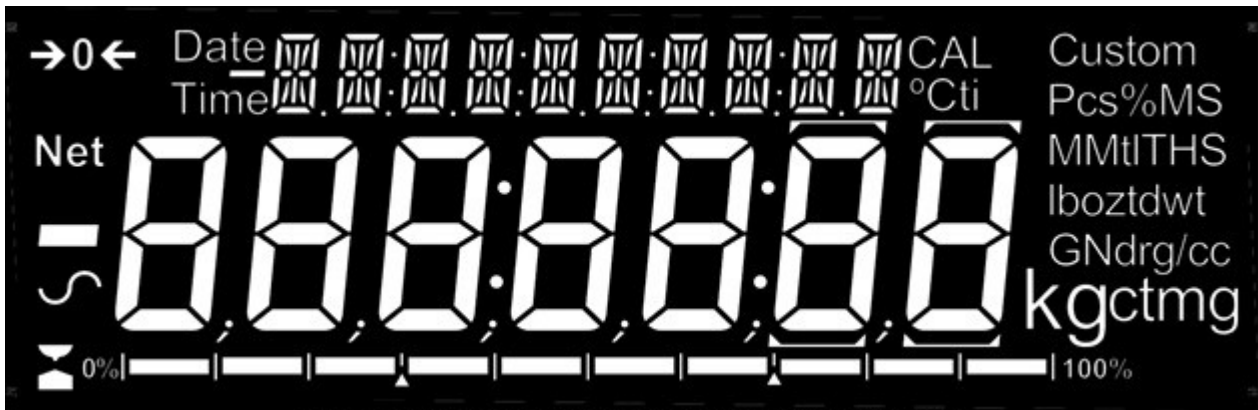

[photo changed – removed battery symbol]

The LCD has several areas-

A large 7 digit area to display the weight with symbols for common weighing units on its right and symbols for zero, tare (Net) and stability on the left.

Text symbols above the display show the current operation or function being used.

### 7.1 SYMBOLS AND TEXT

The LCD has unique symbols to indicate the following:

→0←	Zero
	Busy
	Stable
<b>g, mg, kg, ct, dwt, GN, ozt, oz, N, Custom, g/cc, Pcs, %, </b>	Symbols shown for units and modes

[removed battery symbol from the table above]

Indicators:

<b>“CAL”</b>	When calibration is occurring or about to occur
<b>“ti”</b>	For a time driven calibration
<b>“°C”</b>	When a temperature is shown or a temperature driven calibration is to occur
<b>“Net”</b>	When a net weight is shown

## 8.0 KEYPAD

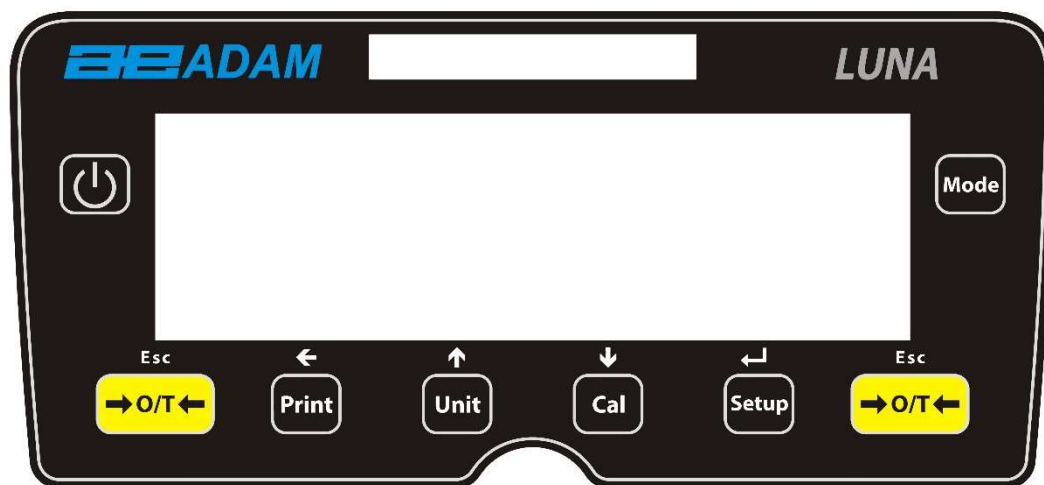

The keypad has the following keys to operate the balance.

Keys	Primary function
	<b>[POWER]</b> To turn the balance to ON or Standby
<b>[→0/T←]</b>	<b>[→0/T←]</b> A combined zero and tare function. To escape from <b>setup</b> functions and modes.
<b>[Cal]</b>	<b>[Cal]</b> Starts the calibration function
<b>[Print]</b>	<b>[Print]</b> Instructs the balance to print data
<b>[Mode]</b>	<b>[Mode]</b> Enters the Mode Selection Menu
<b>[Unit]</b>	<b>[Unit]</b> Selects weighing units by cycling through a set of enabled units.
<b>[Setup]</b>	<b>[Setup]</b> Enters the setup parameters (Supervisor Menus). Enters a function or saves a value while manually entering unit weight or check weighing limits.
	<b>[Left]</b> To advance a flashing digit by one position to the left
	<b>[Up]</b> To increase or change a displayed value or scroll through options forward
	<b>[Down]</b> To decrement or change a displayed value or scroll through options backwards



## 8.1 NUMERIC ENTRY METHOD

To set a value when required, use the keys as given below:-

**[Up]** and **[Down]** symbol keys start entry process, causing the active digit to flash.

Press **[Up]** and **[Down]** to increase or decrease the flashing digit.

Once each digit is set to the required value, use the **[Left]** symbol keys to advance or move back through the digits and then press **[Up]** and **[Down]** to increase or decrease the flashing digit as required.

Once the value displayed on screen is as required, press the **[Setup]** key to accept or enter the displayed value.

Press the **[→0/T←]** key to exit the menu at any time.

## 9 INPUT/OUTPUT



The rear panel has some or all of the following connectors depending on model:

- Power input socket. (Required power input is a low-voltage external supply, LAB,LPB,LTB,LBB series external supply is 18VDC@830mA, Accepts concentric barrel plug 11.4mm length X 5.5mm outside diameter X 2.1mm centre diameter.  
LBL series external supply is 12.6VDC@1000mA, Accepts concentric barrel plug 10mm length×4mm outside diameter×1.7mm centre diameter.
- RS-232 serial - 9 pin d-subminiature plug.  
DB9 F-socket is standard for LAB,LPB,LTP,LBB,LBL series
- USB type A socket.  
USB type A socket is standard for LAB,LPB,LTB,LBB,LBLseries
- RJ45 network interface  
RJ45 network interface is only standard for LBLseries

## 10.0 OPERATIONS

### 10.1 INITIALISATION

If Operator and Supervisor passcodes have been set, the display will show "PASS CODE", shortly followed by "0". In this case you must enter the passcode to continue, using the numeric entry method (see section 10.2). If passcode is incorrectly entered then the message "ErrOr CODE" will flash, shortly followed by "0". Once a passcode is correctly entered, or if passcodes have not been set, the balance will continue as below.



The display will show zero reading along with the zero symbol "→0←" and the weighing unit last used. If automatic time calibration is enabled the balance will calibrate 15 minutes after power up, or again after the pre-set time interval.

### 10.2 PASSCODES

This equipment has passcode security functions which can restrict certain operations to particular users. Supervisor and Operator modes are available. If no passcode is set then the default access is Supervisor level. Setting a Supervisor passcode gives the option to lock down key parameters so that they are not available to be changed by operator-level staff.

If a passcode has been set to limit access to the weighing functions of the balance then when reset or turned on, or when the **[Setup]** key is pressed in Operator mode, the display will show "PASS CD" followed by "0". Use the numeric entry method (see section 8.1) to enter either the operator or supervisor code depending on the access level required. The display shows the digits entered as they are set. The active digit will have the "-" symbol flashing. Make sure to enter the correct passcode to continue. See Section 14.7 for details.

### 10.3 WEIGHING

Press [**→0/T←**] to zero the balance if required. The “→0←” symbol will be displayed.

Carefully place a mass on the pan and the weight will be displayed with the  symbol on the left hand side of the display to indicate that a stable reading has been obtained.

If a container is to be used, place it on the balance and press [**→0/T←**] to tare the weight. When the balance symbol  is on, the “Net” symbol will be displayed to indicate that the balance is tared.

When the display shows zero, place the item to be weighed. Only the net weight will be displayed.

When a tared weight has been stored, pressing [**→0/T←**] again will remove it.

At any time the [**Unit**] key may be pressed to select another unit. Use the [**Up**] or [**Down**] keys to scroll through the units and select the desired unit by pressing [**Setup**], the display will change to show the weight in the selected weighing unit. The available weighing units can be enabled or disabled during setup of the balance (see section 0). Only weighing units that have been enabled will be cycled through when [**Unit**] is pressed.

#### Weighing Units:

You can select alternative weighing units to display the weight by pressing the [**Unit**] key. Depending on model, the available weighing units may include:

	Unit	Symbol	Models	Conversion Factor 1g =	Conversion Factor 1 unit = grams
1	GRAMS	g	All	1	1.0
2	MILLIGRAMS	mg	not 0.01g & 0.1g units	1000	0.001
3	KILOGRAMS	kg	0.01g & 0.1g units	0.001	1000
4	CARATS	ct	All	5	0.2000
5	PENNYWEIGHT	dwt	Some models	0.643014865	1.555174
6	GRAINS	GN	Some models	15.43236	0.0647989
7	TROY OUNCES	ozt	Some models	0.032150747	31.103476
8	OUNCES	oz	Some models	0.035273962	28.349523
9	POUNDS	lb	Some models	0.00220462	453.59237
10	CUSTOM	Custom	Some models	As specified	As specified

It is possible to set the balance to display only grams. Grams will always be one of the units enabled, by default.

If “Custom” unit is available and selected, the balance will prompt for entering a multiplier by displaying “CF 1.2345”, where “1.2345” is the last stored value. Any value ranging from 0.100 to 10.000 may be entered, by which the weight in grams will be multiplied before being displayed. If a multiplier of greater than 1.000 is entered, the number of decimal places displayed will be reduced by one. This multiplier value will be saved for the next use until it is changed by the user.

The balance displays the alternate weighing units with as much precision as possible. For example, the LPB 423 balances (420g x 0.001g) could weigh up to:

Unit	Maximum	d =
<b>g</b>	420	0.001
<b>mg</b>	420000	1
<b>kg</b>	0.420000	0.000001
<b>ct.</b>	2100	0.005
<b>dwt</b>	270.066	0.001
<b>GN</b>	6481.59	0.02
<b>ozt</b>	13.50330	0.00005
<b>oz</b>	14.81505	0.00005
<b>Lb</b>	0.92594	0.00001
<b>N</b>	4.1188	0.0001

## 10.4 FUNCTIONS

When weighing, the user can access the applications that have been enabled (see section 13.2).

The following applications are available depending on model:

- Parts counting
- Percent weighing
- Check weighing
- Animal (Dynamic) weighing (some models)
- Net/ Total
- Density determination (Liquid & Solid) (some models)

The selectable functions can be enabled in supervisor mode and are selected by pressing the **[Mode]** key to enter selection mode. The display will go blank and a small mode symbol will appear at the top of the display, such as “Dynamic”, “Density Solid”, “Parts” etc. Use the **[Up]** and **[Down]** symbol keys to cycle through functions, and press **[Setup]** to confirm your selection, or press one of the **[→0/T←]** keys at any time to return to normal weighing mode.

### **10.4.1 Parts Counting**

This allows the user to weigh a sample of parts to compute an average unit weight and then determine the number of items being weighed by dividing the net weight by the unit weight value. The result is always a whole number of parts.

The balance will have a pre-set number of parts to be used as a sample. These values are 10, 25, 50 or 100 items.

Press **[Mode]** and cycle through the available options until the "Parts" symbol is displayed. Now enter parts counting mode by pressing **[Setup]**.

Press the **[Up]** or **[Down]** key to select the sample size, "5P XX PCS" (where XX=10, 25, 50, 100) then press **[Setup]** to confirm.

When "Ld XX PCS" is shown, place XX number of items on the pan and press **[Setup]** to compute the average piece weight. Display will indicate the total weight in the last selected unit and then show "XX PCS" sounding a beep.

Remove the sample and display will show "0 PCS".

Place an unknown quantity of parts on the pan. The balance will then compute the number of parts based on the average piece weight. The display will show the result in number of pieces. This will be an integer value in the format "XX PCS".

To count another item press **[Mode]** and continue as before.

Checks will be made to determine that the weight of the reference parts is large enough for reasonably accurate counting (the weight of each piece must be > 1 division of the balance).

To return to normal weighing, press the **[Esc]** key.

### **10.4.2 Percentage Weighing**

Percent weighing will be done by defining a certain weight to be 100%. The weight to be used can either be entered by the user or taken from a sample

Press **[Mode]** and then the **[Up]** or **[Down]** key until the "Percent" symbol is displayed. Now enter percent weighing mode by pressing **[Setup]**.

Display will show, "SAMPLE %" (sample method) or "ENT WT %" (manual weight method). Press the **[Up]** or **[Down]** keys to toggle between the two methods and press **[Setup]** to select the desired method.

#### **10.4.2.1 Sample method:**

When "SAMPLE %" is displayed, press **[Setup]**.

When "LOAD" followed by "100 %" is shown, carefully add the sample to the pan. Now press **[Setup]** to set this weight to be 100%. The display will show "REF WT" and the sample weight in the last selected unit. After a short pause, "100 %" will be displayed.

Remove the sample and "0.00 %" will be displayed

Now place an unknown sample on the pan to display the percentage weight relative to the original sample.

To set another weight as 100%, press **[Mode]** and repeat as before or press **[Esc]** to return to normal weighing.

#### **10.4.2.2 Manual method:**

To manually enter a value to be set as 100%, when "Ent 1% " is displayed, press **[Setup]**. The display will briefly show " 100 1%" followed by a weight value in the unit last used in the weighing mode.

Change the displayed weight to the required sample weight using the direction keys and numeric entry method and press **[Setup]** to enter the value. The display will now return to zero.

Now place unknown samples on the pan to display the percentage weight relative to the set sample weight.

To repeat percent weighing with another sample press **[Mode]** and continue as before, or to return to normal weighing mode, press **[Mode]** followed by **[→0/T←]**.

**NOTE:** Percentage will be initially displayed to the maximum number of decimal places based on the resolution of the balance. To increase or decrease by one decimal place, press the **[Up]** or **[Down]** key respectively.

#### **10.4.3 Check weighing**

- Press **[Mode]** and then the **[Up]** or **[Down]** keys until the check symbol is displayed.
- Now enter check weighing mode by pressing **[Setup]**.
- Display will show Low Lim (L0 Li 1); press **[Up]** or **[Down]** keys to toggle this from "on" to "off". If the lower limit is set to "on", pressing **[Setup]** key will allow you to enter a value for the lower limit using the numeric entry method.
- If the lower limit is set to "off", pressing the **[Setup]** key will then show the last value set for the high limit; this can be changed using the numeric entry method.
- If a low limit is set the next option is to set the high limit using numeric entry method.
- Once the high limit is set, the next option displayed is "Buzzer", available settings for this, using the **[Up]** and **[Down]** keys, are: "off", "in" and "out". The settings determine when an audible alarm sounds, either never, when the weight is in the limits or outside of set limits. Once set, press the **[Setup]** key to begin check weighing.
- Pressing **[Mode]** and then **[Esc]** key returns to normal weighing.

#### **10.4.4 Animal (Dynamic) Weighing**

The balance can be set to weigh animals or unstable/moving items. This is commonly referred to as 'Dynamic' or 'Animal' weighing mode. The balance will collect the weight over a period of time to arrive at an average value and display the value until the operator resets the balance. The actual weighing process can begin either automatically when the weight is placed on the pan, or when initiated by the operator. The weighing unit can be selected as normal using the **[Unit]** and **[Setup]** keys, before starting the dynamic weighing process.

##### **Steps:**

Press **[Mode]** and then the **[Up]** or **[Down]** key to cycle through available modes. When the "Animal" symbol is displayed, press **[Setup]** to enter animal weighing mode. "run" will now be displayed on the screen.

Press **[Up]** or **[Down]** to select "run" for starting the dynamic weighing, or "SEtUP" to set up the balance for dynamic weighing (see section 10.4.4.3 on Dynamic Weighing Setup Parameters).

During dynamic weighing, if the **[Print]** key is pressed, the balance will display "PRINt" for 1 second, then show the current average weight with the "Animal" symbol flashing.

To resume, press **[Print]** again or if you do not wish to continue then pressing **[Mode]** will display "StOP" for one second and then show the final value. The value will be locked until the user releases it.

##### **10.4.4.1 Manual mode**

When the balance is in the "MANUAL" mode:-

If **[Setup]** is pressed when "run" is selected, balance will display "StArt".

Place the item on the pan and press **[Setup]** again.

After the pre-configured delay and test time have elapsed (see section 10.4.4.3 on Dynamic Weighing Setup Parameters), the "Hold" symbol and the result will be displayed.

Remove the item from the pan. Press **[Mode]** to go back to "run" to weigh another item, or **[→0/T←]** to return to normal weighing.

##### **10.4.4.2 Auto mode**

When the balance is in the "Auto" mode:-

If **[Setup]** is pressed when "run" is selected, the balance will display "LOAD PAN".

Place the item on the pan. The animal weighing test will begin automatically.

After the pre-configured delay and test time have elapsed (see section 10.4.4.3 on Dynamic Weighing Setup Parameters), the "HOLD" symbol and the result will be displayed.

Remove the item from the pan. Press **[Mode]** to go back to “rUn” to weigh another item, or **[→0/T←]** to return to normal weighing.

#### **10.4.4.3 Animal (Dynamic) Weighing Setup Parameters**

When the “Animal” text is displayed, and you have selected “SEtUP” to set up the balance for dynamic weighing (follow the set up instructions below):

The display will show “iOdE”. Press **[Setup]** again and use the **[Up]** or **[Down]** keys to select “AutE0” or “iirAnuAL”.

If “AutE0” [deleted text] is selected, the following 3 parameters are available:

- Threshold “tHrE5H”
- Test time “tE5t t”
- Delay “dELAY”

If “iirAnuAL” is selected, the following 2 parameters are available:

- Test time (“tE5t t”)
- Delay “dELAY”

##### **10.4.4.3.1 Threshold “tHrE5H” (For Auto mode only)**

Press **[Setup]** when “tHrE5H” is shown and the display will next show the minimum weight of the item required by the balance to start the process for dynamic weighing. The value shown will be the current value in the last selected unit.

The minimum threshold value can be changed from 1.0 to 100 grams using the keypad numeric entry method.

To confirm the desired value, press **[Setup]** or to escape without changing the value, press **[Mode]**.

##### **10.4.4.3.2 Test time “tE5t t”**

Press **[Setup]** when “tE5t t” is shown and the display will next show the number of seconds over which the balance will average to compute the final weight. The **Test time** value can be changed to between 10 - 99 seconds using the keypad numeric entry method.

To confirm the desired value, press **[Setup]** or to escape without changing the value, press **[Mode]**.

##### **10.4.4.3.3 Delay “dELAY”**

Press **[Setup]** when “dELAY” is shown and the display will next show the number of seconds pause before the sampling starts. The **Delay** value can be changed to between 0-99 seconds using the keypad numeric entry method.

To confirm the desired value, press **[Setup]** or to escape without changing the value, press **[Mode]**.

##### **10.4.4.3.4 Mode “iOdE”**

Auto “AutE0” or Manual “iirAnuAL” modes are available. Whichever mode is visible when



**[Setup]** is pressed becomes the active mode. **Auto** starts dynamic weighing test as soon as weight exceeding a set threshold is loaded on the pan. **Manual** requires the user to load the pan and then press a button before weighing commences.

#### 10.4.5 Net / Total

- Press **[Mode]** in normal weighing using **[Up]** and **[Down]** keys; select “**Net/Tot**” press **[Setup]** key to enter this function.
- Put a weight on the pan; when stable symbol displayed press **[Setup]** key, this will store the weight value; press **[→0/T←]** key to zero.
- You can keep adding weights and storing the new total weight using the above steps.
- Pressing the **[Mode]** key shows the total recorded weight, pressing **[Esc]** key returns to normal weighing.

#### 10.4.6 Density Determination

It is possible to determine the density of solids or liquids using this mode. The user selects the type of density to be determined and then enters values to be used by the balance.

The density mode allows the user to use a special Density Kit or use the below pan weighing facility to perform the necessary weighing.

##### 10.4.6.1 Density of Solids

To perform the density of solids test, the user must have a method to immerse the sample in the chosen liquid. The density of the liquid must be known or determined from a look-up table.

##### Steps:

Press **[Mode]** and then **[Up]** and **[Down]** keys until “Density Solid” or “Density Liquid” symbol is displayed and then press **[Setup]** to enter chosen density mode.

When “Density Solid” is selected, the type of liquid used for the test must be selected:

Press **[Up]** or **[Down]** to select the liquid – water (display “**WATER**”), ethanol (“**ETHANOL**”), or other (“**OTHER**”).

##### For **Water** and **Ethanol**:

The density will be calculated based on the liquid temperature. A prompt “**WATER T**” or “**ETH T**”, shortly followed by a numeric value e.g. “**20.0**” and the “**°C**” symbol at the top left of the display will appear. Measure and enter the temperature of the fluid using the keypad numeric entry method (see section 8.1).

or

##### For **Other**:

The liquid density value must be accurately known, and entered manually. A value will appear on screen e.g. “**0.500 g/cc**”. Enter the known density (g/cc) using the numeric entry method (see section 8.1). Value must be in the range **0.5 ≤ 2.0**. If a value outside this range is selected then it will not be accepted and “**Er LD**” or “**Er HI GH**” will be displayed followed by return to the time entry screen again.

To confirm the desired value, press **[Setup]** or to escape without changing the value, press **[Mode]**. The display will show “**XX.XXX g/cc**”. Press **[Setup]** to continue.

The balance will now request the weight of the sample in air by displaying “**AI r 1.5**”. Place the item on the pan, or in receptacle if the density kit is used, and press **[Setup]**. The weight in air will briefly be shown in the last weighing unit selected.

After completion of the air weighing, the balance will request the weight in liquid by displaying “**LI 9 1.5**”. Submerge the item in the liquid and press **[Setup]** to start the liquid weighing. The weight in liquid will briefly be shown in the last weighing unit selected, followed by the computed density of the sample displayed as “**XX.XXX g/cc**”.

Remove the item from the pan and press **[Mode]** to continue with a new sample or press **[→0/T←]** to return to normal weighing.

#### **10.4.6.2 Density of a Liquid**

When finding the density of a liquid, it is necessary to weigh a sample of known volume in air and then in the liquid. The volume of the sample must be entered by the user. The last known volume is stored for use at any time.

If using the density determination kit, the volume of the plumb is marked on its support, e.g. 10.123 cc.

##### **Steps:**

Press **[Mode]** and then **[Up]** and **[Down]** keys until “**Density Liquid**” symbol is displayed and then press **[Setup]** to enter this chosen density mode.

When “**Density Liquid**” is selected, the type of liquid used for the test must be selected:

The volume will be asked for by displaying “**uDLu7E**” followed by a value which is the bulb volume in cubic centilitres (cc). Enter or change the volume if required, using the keypad numeric entry method (see section 8.1) and then press **[Setup]** to continue.

The balance will now request the weight in air by displaying “**AI r 1.5**”. Place the glass plumb supplied with the density determination kit in air on the weighing pan and press **[Setup]** to start the air weighing. The value will briefly be shown in the last weighing unit selected. The balance will now request the weight in liquid by displaying “**LI 9 1.5**”.

Submerge the glass plumb in the liquid and press **[Setup]** to start the liquid weighing. The weight will briefly be shown in the last selected unit, followed by the computed density of the sample displayed as “**XX.XXX g/cc**”

Remove the item from the pan.

Press **[Mode]** to continue with a new sample or press **[→0/T←]** to return to normal weighing.

If a printer or other serial device is connected then pressing **[Print]** will print the density value in g/cc.

## 1 RS-232 INTERFACE

The balances have the ability to send or receive data over the serial interfaces, RS232 and USB. Both interfaces are controlled by the parameters detailed below. If the host computer to be used does not have a serial port then a USB-RS232 convertor accessory can be used.

The USB and RS232 both operate as general purpose serial data ports. Weighing data can be sent over the interface either automatically, by command, or when the user presses the [**Print**] key. Connection can be made to a printer, remote terminal or other device with a compatible serial data port.

### 1.1 HARDWARE

- The RS-232 interface is a simple 3 wire connection. A standard RS232 M-F cable can be used.
- 
- The input and output connections are:
  - Connector: 9 pin D-sub miniature socket
  - Pin 2 Output from balance TXD
  - Pin 3 Input to balance RXD
  - Pin 5 Signal ground GND
  -

Handshaking is not applied.

Baud rate: Selectable 4800, 9600, 19200, 38400

Parity: Selectable NONE (=8N1), EVEN (=7E1) or ODD (=7O1)

All lines are terminated with carriage return and line feed (<CR><LF>).

To connect to a device, the correct cable must be used, and port settings on both connected devices must match. The RS232 and USB connector (if fitted) both output simultaneously, so it is possible to have more than one connection at once.

To configure output mode, frequency and formats, see section 14.3 and 14.4

### 10.5 OUTPUT FORMATS

#### 10.5.1 Single-line output format

In continuous output mode, or if single-line output on demand is selected, the serial output format will be a single line in the form " **1234.567** g<CR><LF>".

**NOTE:** The format of the result will change depending on the mode in which the balance is operating, e.g.

- Normal weighing, Animal weighing: " **123.456** g"
- Parts counting: " **1234 pcs**"
- Percent weighing: " **12.345 %**"

- Density: "12.345 g/cc"

### 10.5.1.1 Standard output format

The balance will print the following data as the standard form. The standard form cannot be changed. The format of the custom forms #1 and #2 will be the same as the standard form until modified by the user.

Line 1	Date
Line 2	Time
Line 3	Blank line
Line 4	ID number
Line 5	Blank line
Line 6	Result
Line 7	Blank line
Line 8	Blank line

This will result in a printout that looks like:

Date:	01/01/19
Time:	15:45:27
ID No:	123456
Net:	123.456

**NOTE:** The format of the result line will change depending on the mode in which the balance is operating, e.g.

- Normal weighing, Animal weighing: “**123.456 g**”
- Parts counting: “**1234 pcs**”
- Percent weighing: “**12.345 %**”
- Density: “**12.345 g/cc**”

### 10.5.2 Custom output format

If output on demand is selected, the user may optionally configure the serial output as a choice of 3 styles of form, either in a default format or in one of two custom formats. Each of the custom formats can be configured to output up to 15 lines of data. The data types that can be printed are:

NAME	TEXT PRINTED
ID number	ID no.: xxxxxxxxxxxx
Serial number	Serial no. xxxxxxxxxxxx
Date	DATE dd/mm/yyyy
Time	TIME hh:mm:ss
Net weight	Net: xxx.xxx g
Gross weight	Gross: xxx.xxx g
Tare weight	Tare: xxx.xxx g
Unit weight	Unit wt: xxx.xxx g
Count	Count: xxxx pcs
Reference weight	Ref. wt: xxx.xxx g
Percent	Percent: xx.xxx %
Checkweigh lower limit	Low: xxx.xxx g
Checkweigh upper limit	High: xxx.xxx g
A blank line printed	<CR><LF> only.

Any of these can be printed on any of the 15 lines available. Not all items need to be used and any one can be used more than once (see section 14.4).

The data for each form will be preceded by a start-of-header <SOH> ASCII character (01) and terminated with an end-of-transmission <EOT> ASCII character (04). These characters will be ignored by a serial printer but will allow a computer program which reads the data to distinguish between this block report format and the single-line output format described above.

## 10.6 INPUT COMMANDS USING REMOTE KEYS

The balance can be controlled with the following commands sent using remote keys such as from a PC. The commands must be sent in upper case letters, i.e. "KT" not "kt". Press the Enter key of the PC after each command (the action of Carriage Return is denoted as <CR> as shown below).

Basic Input Commands:

<b>!KT&lt;CR&gt;</b>	Tares the balance to display the net weight. This is the same as pressing the [ <b>→0/T←</b> ] key when the balance is in the normal weighing mode.
<b>!KS&lt;CR&gt;</b>	Enters the setup section. This is the same as pressing the [ <b>Setup</b> ] key when the balance is in the normal weighing mode.  Once entered the setup section, the balance can be controlled remotely using the Input Commands (as mentioned in this table) which will perform the same key functions as described in section.
<b>!KP&lt;CR&gt;</b>	Transmits data over RS-232 interface. This is the same as pressing the [Print] key when the balance is in the normal weighing mode.
<b>!KM&lt;CR&gt;</b>	Enters the Modes section. This is the same as pressing the [ <b>Mode</b> ] key when the balance is in the normal weighing mode.
<b>!KC&lt;CR&gt;</b>	Enters the Calibration section. This is the same as pressing the [ <b>Cal</b> ] key when the balance is in the normal weighing mode.
<b>!KU&lt;CR&gt;</b>	Enters the Unit selection section. This is the same as pressing the [ <b>Unit</b> ] key when the balance is in the normal weighing mode.

### 10.6.1 Invalid input command:

If an invalid command is received, then the command is returned as follows-

Invalid Command	Message returned	Remarks
!NT<CR>	!EU<CR>	Command character is not 'K'
!KK<CR>	!EK<CR>	Key character is not 'T', 'S', 'P', 'M', 'C' or 'U'
!KT-<CR>	!EF<CR>	Command format error, <CR> is not the fourth character
KT<CR> or !KT -	No reply	Either '!' or <CR> is missing in the command string

When the remote display output is used with the Adam Equipment Remote Display unit, the output is a continuous stream of data representing the weight and other information to display the correct data on the remote display.

If the remote display data stream format is required for development purposes then please contact the manufacturer for advice.

## 12 RJ45 network interface

### 12.1 OVERVIEW

The network module of ADAM balance is NET-UART-9120 serialNet module, which can realize two-way transparent transmission of data between balance and computer (or upper computer) through local area network.

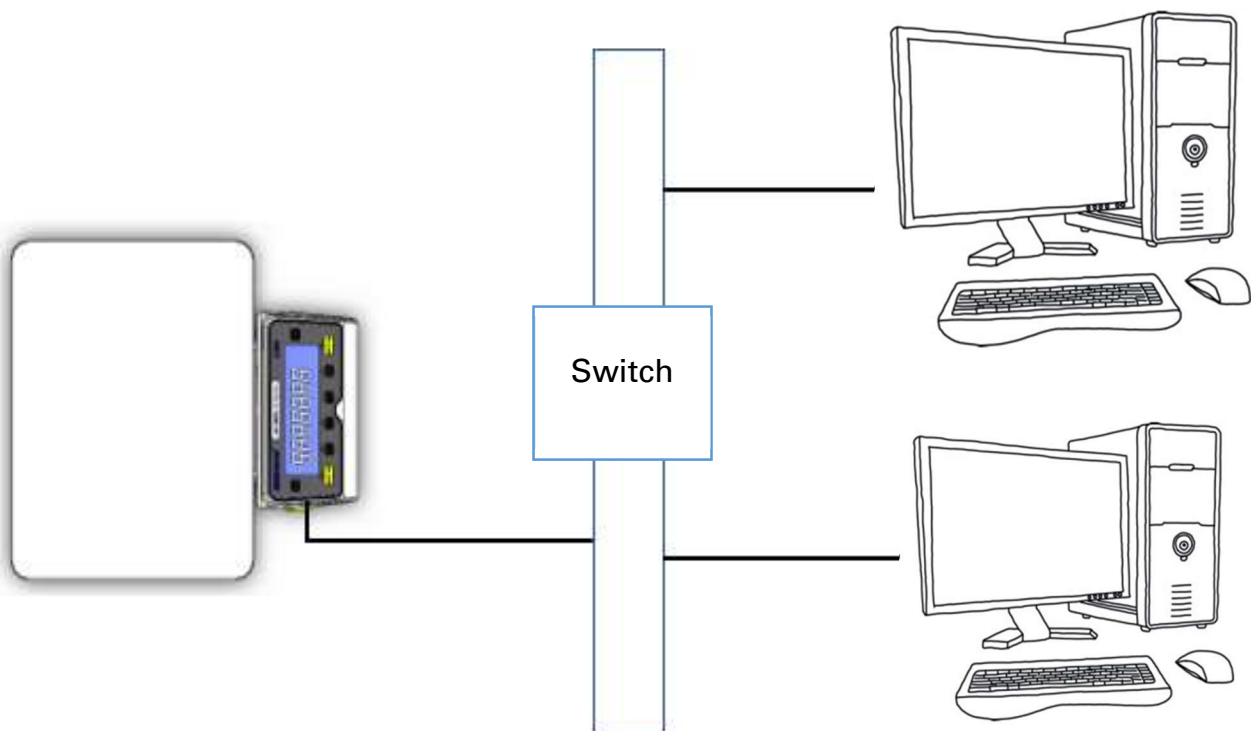

## 12.2 Connecting

First, you need to set the computer IP address to 192.168.1.X/24 network segment when using "CH9120 Network Configuration Tool" for the first time.

1. **Select "Start"**, and then enter " Settings". > "network & Internet "select "settings".
2. **Select "Ethernet"**, and then select the Ethernet network you are connected to.
3. **Next to "IP Assignment"**, select "Edit".  
Under "Edit Network IP Settings "or "Edit IP Settings", select "Manual".

### Manually specify IPv4 settings.

1. **Under Edit IP Settings**, select Manual, and then open IPv4.。

To specify an IP address, type the IP address settings in the IP address, subnet mask, and gateway boxes.

**NEXT** Open the "CH9120 Network Configuration Tool" to configure the device IP and network mode.

1. Click "search device"
2. Type Device Name, IP Address, Subnet Mask and Gateway, select TCP server as Network Mode, and click Configure Device Parameters to save the configuration.
3. Ping command can be used to detect the connectivity of network connections.

Open the "SER-NET" tool, select "protocol type" TCP Client, type "target IP" and click "connect".

## 12.3 Output format and remote instructions

The output format and remote instructions of the network interface are consistent with RS232, and both of them will be changed at the same time. See Chapter 11.2 for changing the output format and Chapter 11.3 for remote instructions.



## 13.0 ERROR CHECKING

During weighing the balance is constantly checking to see if it is operating within the limited parameters. The errors likely to occur are:

- A/D counts below lowest allowed value
- A/D counts above highest allowed value
- A/D not operating
- Maximum capacity exceeded

Other errors may be detected during special functions or operations. These will be described in the section that applies.

Error messages and the reasons are:

<b>Concerning A/D counts</b>	
<i>Err UL</i>	A/D counts below a limit
<i>Err DL</i>	A/D counts above a pre-set limit
<b>Concerning calibration</b>	
<i>Err Stb</i>	Calibration could not be completed because the results were not stable
<i>Err LD or Err HI</i>	Calibration constant not within 20% of old calibration constant
<b>Concerning weighing</b>	
<i>Err LD</i>	Weight display is below zero by >4%max
<i>Err HI</i>	Weight is above maximum plus 90d

## 14.0 SUPERVISOR MENUS

Pressing the **[Setup]** key while in normal weighing gives access to the menus.

When **[Setup]** is pressed and the Supervisor Passcode is not enabled the display will allow access to the Supervisor menus. If passcode is enabled, the balance will ask for it by displaying "PASS Cd" shortly followed by displaying "0".

If a passcode is incorrectly entered then the message "Er CODE" will flash and the display will return to "PC OPER" or "PC SUBE".

If the passcode has been enabled and correctly entered, the balance will allow the operator to access the Supervisor's menus by which the user can enable/disable weighing units or modes, set balance parameters for the conditions, set time and date, set parameters for the RS-232 interface, calibration parameters and security parameters.

The display will show the first menu item "Unit t5". The **[Up]** and **[Down]** keys will cycle through the main menu items and pressing **[Setup]** will enter the sub-menu, or options can be set. Press **[Mode]** to exit out of a sub-menu, or **[→0/T←]** to return to normal weighing

### 14.1 ENABLE WEIGHING UNITS

When "Unit t5" is displayed, press **[Setup]**. The right hand side of the display will show the symbol for the first unit, e.g. carats, ct, together with its enable state "OFF" or "On". The Supervisor can then enable or disable the carats unit by using **[Up]** or **[Down]**. Pressing **[Setup]** will confirm the setting and will advance to the next weighing unit. Repeat for each weighing unit in turn. Note: Grams, g, is always enabled.

Press **[Mode]** to advance to setting of the next menu or press **[→0/T←]** to return to normal weighing

### 14.2 ENABLE WEIGHING MODES

The same steps are followed to enable or disable the weighing modes:

Press **[Setup]** when "MODES" is displayed. The top of the display will show the symbol for the first mode e.g. Parts Counting ("Parts") together with its enabled state "OFF" or "On". The user can enable or disable the parts counting mode by using **[Up]** or **[Down]**. Pressing **[Setup]** will confirm the setting and will advance to the next weighing mode. Repeat for each mode in turn.

Press **[Mode]** to advance to setting of the next menu, or press **[→0/T←]** to return to normal weighing

### 14.3 ENABLE SERIAL INTERFACE PARAMETERS

The parameters affecting the serial interface are set in a similar manner to the other parameters.

**Note:** The balance must be power-cycled to apply changes to serial port settings.

Press **[Setup]** when "SERIAL" is displayed to enter the sub-menu.

The parameters that can be set are:

<b>Enable</b>	On = serial port enabled OFF = serial port disabled
<b>Baud</b>	Set Baud Rate. Selectable values: 4800, 9600, 19200 or 38400
<b>Parity</b>	Set Parity. Selectable values: nOnE, EUn or Odd
<b>Stable</b>	ON = print only when reading is stable OFF = print regardless of stability
<b>Continuous</b>	ON = Send data continuously over serial port OFF = Only send data when <b>[PRINT]</b> is pressed
<b>Periodic</b>	ON = Set the RS-232 to send data periodically. Range 1 to 999 seconds OFF = No periodic data transmission
<b>Format</b>	Format of serial output data. Selectable parameter from: SINGLE = Serial data output sent as a single line STANDARD = Serial data output sent in standard format FORM 1 = Serial data output sent in custom-designed format FORM 1 FORM 2 = or FORM 2 (See section 14.4).

#### 14.4 FORMAT OF CUSTOM FORMS #1 and #2

If FORM1 or FORM2 is selected, the format be changed by the user using a selection of available data. By default the 2 forms are the same as the standard form unless changed by the user as below.

When "FD-111 1" or "FD-111 2" is selected, the user can set the information to be printed on each line of the form. Pressing the <b>[Up]</b> or <b>[Down]</b> keys will cycle through the options available. The options are:	
<b>Inst Id</b>	Instrument ID number
<b>SER no</b>	Serial Number
<b>TIME</b>	Time
<b>DATE</b>	Date
<b>Net</b>	Net Weight (Gross weight – Tare Weight)
<b>Gross</b>	Gross Weight
<b>TARE</b>	Tare Weight
<b>unit</b>	Unit weight in parts counting mode
<b>Count</b>	Number of items in parts counting mode
<b>REF</b>	100% weight in percent weighing mode
<b>PERCENT</b>	Percentage of reference weight in percent weighing
<b>LO LI</b>	Low Limit when check weighing (Not used)
<b>HI LI</b>	High Limit when check weighing (Not used)
<b>CR LF</b>	Inserts a blank line
<b>End</b>	Signifies the end of the report (When END is entered the display returns to the <b>SERIAL</b> Sub-menu)

Enter the data to be printed on the first line by pressing **[Up]** or **[Down]** to cycle through the options. If the current information is OK then press **[Setup]** to move to the next line.

e.g. "LI nE 0 1", "DATE" – will print date on first line of output form.

Select a code for one of the pre-set data formats as detailed above.

The next line shows: "LI nE 02" "Ei nE" - prints time.  
Only one item can be entered per line.

Continue until the formatting of the form is complete. There are 15 lines of possible data. After the 15th line has been set or "End" has been selected, the balance will return to the "SERIAL" Sub-menu.

Press **[Mode]** to advance to setting of the next menu, or press **[→0/T←]** to return to normal weighing.

## 14.5 SETUP PARAMETERS

The user parameters that control the balance are shown under the setup menu. When "SETUP" is displayed, press the **[Setup]** key. The options for each parameter can be scrolled through by using the **[Up]** or **[Down]** key. Use the **[Up]** and **[Down]** keys to increase or decrease the value for setting. Press **[Setup]** to accept the setting and advance to the next item in the menu

Press **[Mode]** to advance to setting of the next parameter or **[→0/T←]** to return to normal weighing

LANGUAG	Select menu language from available options.
Ei nE	Set real-time clock using the keypad numeric entry method. HH:MM:SS.
DATE FOR	Set date display format using the keypad numeric entry method. European (DD/MM/YY) or USA format (MM/DD/YY).
DATE	Set date using the keypad numeric entry method. YEAR, MONTH, DAY, WEEKDAY
Ident	Enter a user number to identify this balance on print output. Range 1 - 9999999
buZZEr	On = Enable sound alerts OFF = Disable sound alerts
BACKLI	AUTO = Always on unless balance is not used for 5 minutes, then turns off automatically until key is pressed or weight >20d is detected. ON = Permanently on [text deleted]
Power do'n	On = Power-saving mode <b>enabled</b> . Sets the inactivity period after which unit will go into stand-by mode. Range 1 – 9 minutes. OFF = Power-saving mode <b>disabled</b> .
Filter	The filter tracks and averages weighing to produce the most accurate measurement and smooth out instabilities. A higher filter number means more filtering and a slower, but possibly more stable and accurate response. A lower number will produce a quicker measurement but it may be less stable and accurate. Range 1 (low) to 9 (high). Recommended value for normal use: 5
Filter	ON = A fine filter which provides better performance when weighing whilst pouring a substance such as liquid or powder into a container on the pan. OFF = No filtering. Recommended setting for normal use.
Stabil	Set a value to be used to determine balance stability. The number corresponds to the number of divisions the weight reading is fluctuating by. A larger number corresponds to a larger stable zone. Selectable values: 1, 2, 5 or 10 (divisions). Recommended value for normal use: 1
Auto-Zero	ON = Auto-zero function. Selectable values: 1, 2, 5, 10 or 15 (divisions). OFF = Auto-zero function disabled. Recommended value for normal use: ON, 5
SEPAR	COMMA Set separator indicator on the display to be either a decimal point DEC PT or a comma. Also applies to the serial interface for print output.

## 14.6 CALIBRATION SETUP

This menu allows the Supervisor to set the calibration parameters. Press **[Setup]** when "CAL SET" is displayed to select the calibration parameters. The options for each parameter can be scrolled through by using the **[Up]** or **[Down]** key and pressing **[Setup]** to confirm choices.

EnAbLE	NO = Operator calibration is disabled. YES = Operator calibration is enabled.
CAL rEP	ON = Prints out Calibration report after successful calibration. OFF = Disabled.
tI n CAL	ON = Enabled. Select time from 1 to 24 hours. OFF = Disabled.
tE n CAL	ON = Enabled. Select the temperature variation from 0.2 to 4°C which when detected will trigger automatic calibration. OFF = Disabled.
I n t CAL	YES = Internal calibration enabled (if fitted). NO = External calibration enabled.
I n t M AS	CAL MAS = Displays the set value of the internal calibration mass (if fitted) in grams. If after verification against an external mass it is determined that the value of the internal mass needs adjustment, e.g. due to wear, accumulation of dirt, etc., then this value can be adjusted by +/- 100 mg. This should only be considered by expert users if the external reference weight is definitively accurate and an incorrect weight reading is being given after internal calibration. Adjustment will restore the internal calibration to the correct level of accuracy.

Press **[Mode]** to advance to setting of the next menu or **[→0/T←]** to return to normal weighing.

## 14.7 PASSCODES

To enable the security features in this balance it is necessary to set passcodes. There are 2 passcodes called Operator Passcode and Supervisor Passcode. The Operator Passcode allows an authorised user to operate the basic weighing functions of the balance but will not allow access to the Supervisor Menus if the Supervisor Passcode has been set.

**Note:** To change or disable a Passcode it is necessary to enter the current passcode.

To setup passcodes:

Press **[Setup]**. Use the **[Up]** and **[Down]** keys to cycle through options until "PASSC0d" is displayed. Press **[Setup]** again to enter this section. Use **[Up]** and **[Down]** keys to select Operator ("PC 0PEr") or Supervisor ("PC 5uPE") option.

PC 0PEr	Press <b>[Setup]</b> . "0" will be displayed. Enter the current passcode (OLD) first and press <b>[Setup]</b> . If correctly entered then "nE!" will be displayed briefly followed by "0". Enter a new passcode if desired or press <b>[Mode]</b> or <b>[→0/T←]</b> to leave the existing password unchanged and return to normal weighing. <b>Note:</b> A passcode set to zero will disable the security feature and allow unlimited access.
PC 5uPE	Press <b>[Setup]</b> . "0" will be displayed. Enter the current passcode (OLD) first and press <b>[Setup]</b> . If correctly entered then "nE!" will be displayed briefly followed by "0". Enter a new passcode if desired or press <b>[Mode]</b> or <b>[→0/T←]</b> to leave the existing password unchanged and return to normal weighing. <b>Note:</b> A passcode set to zero will disable the security feature and allow unlimited access.

If a passcode is incorrectly entered then the message "Er CODE" will flash and the display will return to "PC OPER" or "PC SUPER".

### **Forgotten Passcodes:**

Keep a record of the passcode to ensure you can access this section again. If however you have forgotten your passcode you can still gain access by entering a universal code.

If you have forgotten the current passcode a code of "15" will always allow you to enter the Supervisor area. Using the Supervisor menus, go to PASSCODE section. Reset the Operator or Supervisor passcode using "15" as the old passcode when prompted.

## **15.0 ACCESSORIES & SPARE PARTS**

**(Available from your accessories supplier)**

Accessories that are available for use with the balance include the following:

### **15.1 DENSITY DETERMINATION KIT (For 0.0001 g and 0.001 g units only)**

The Density Determination Kits include everything needed to carry out precise and repeatable measurement. The kit allows a sample to be weighed in air and then a liquid to determine the density of the sample. It also allows a glass sinker of known volume to be weighed in air or in a liquid, to determine the density of the liquid.

### **15.2 ANTI-VIBRATION TABLE**

The anti-vibration table is a support for laboratory balances that isolate the balance from vibration through the floor. The table has a granite surface for the balance with a separate table top surrounding the balance.

### **15.3 ADAM THERMAL PRINTER (ATP)**

A compact thermal printer is available which is ideal for use with laboratory balances.

### **15.4 ADAM IMPACT PRINTER (AIP)**

A high speed, compact and concise, dot-matrix printer supplied with RS232 interface and USB port is available as well.

### **15.5 BELOW-BALANCE WEIGHING HOOK**

If objects are too large or difficult to place safely on the weighing pan of a balance then a load can be supported from a hook on the underside of the balance. This application is commonly referred to as "below balance" or "underfloor" weighing. All models in the Luna range are equipped with the facility to attach a hook below the balance and suitable hooks are available. No special software is required – weighing processes are otherwise performed as normal.

### **15.6 IN-USE PROTECTIVE COVER**

For cleanliness and hygiene reasons, and to protect the keypad and display from liquids, chemicals and particulates, and general wear, use of a transparent semi-disposable protective slip-on cover is highly recommended.

## 15.7 SECURITY LOCK

A fixed security loop is designed into the rear of the balance. A cable lock is available which can be passed through the loop and locked to a fixed point e.g. workbench to reduce incidences of theft.

[delete the remote display text – old 14.7 chapter]

## 15.8 DUST COVER

A vinyl dust cover is available to protect your equipment whilst not in use.

## 15.9 ADAM DU - Data Capture Utility for ADAM Balances & Scales

ADAM DU (Data Utility) is an application that allows you to quickly and easily capture data from an ADAM Laboratory Balance or Weighing Scale and perform various functions on the collected readings such as graph the data, perform basic mathematical statistical analysis, export the readings to several common file formats. Also quickly export data to other applications (e.g. MS Excel, MS Word or the Windows Clipboard). ADAM DU also provides basic remote control of the balance/scale.

ADAM DU can collect data from up to 8 different balances/scales simultaneously, each data collection session can be individually monitored, configured and customised to your requirements. Adam DU can also speak the readings received. This is ideal if you want to stay informed of a scale's progress whilst completing other tasks, or maybe you might be visually impaired. See <http://www.adamdu.com/> for further details and to download a free evaluation copy.

If you need to order any spare parts and accessories, contact your supplier or Adam Equipment. A partial list of such items is as follows:

- Power Supply Module
- Stainless Steel top Pan
- Draft shield/breeze shield parts
- Serial and printer cables, etc.
- Replacement keypad

**Note:** *Not all items are available for all models or can be fitted by end user. Some require dealer or service agent fit.*

## 16.0 SAFETY AND MAINTENANCE

### **CAUTION**

Use the AC adapter designed by the manufacturer for the balance. Other adapters may cause damage to the balance.

[Delete text referring rechargeable battery]

Avoid subjecting the balance to rough treatment or shocks during transport, setting up and operation. Do not overload the balance beyond its maximum capacity, and do not drop material onto the platform which could damage the balance.

Do not spill liquids on the balance as it is not water-resistant. Liquids may damage the case and if it gets inside the balance it may cause damage to the electronics. Use of our special transparent in-use protective covers is recommended.

Material that has a static electric charge could influence the weighing. Discharge the static electricity of the samples, if possible. Another solution to the problem is to wipe both sides of the pan and the top of the case with an anti-static agent.

## 17.0 TROUBLE-SHOOTING

Service of a Luna balance will generally be necessary when the balance does not perform as expected. The balances are not user-serviceable. For Service Information, see section 18.0 and contact Adam Equipment or your supplier.

Problems usually fall into one of the following categories:

- **User Problems:**

The user is asking the balance for something it cannot do or is confused by the modes and functions of a balance. It is also possible the user has set a parameter that has affected the balance operation. Resetting the parameter to a normal value will restore operation.

- **Mechanical Problems**

The balances consist of complicated and fragile mechanical devices. They can be damaged by placing a weight on it which is too high for the balance, or by dropping the balance or occasionally shipping it without taking care. The most fragile parts are the flexures. Dust, dirt, spills and other foreign objects in the balance can also cause problems.

- **Electronic Problems:**

These are the rarest of the problems affecting balances. If an electronic problem is suspected make sure the mechanical problems that can cause similar symptoms have been eliminated before attempting electronic repairs. With the exception of cables most electronic repairs are solved by board replacement.

The trouble-shooting table in section 16.1 is a guide of common problems and their solutions. Note that many problems may have multiple solutions and there may be problems found that are not listed in the table. For Service Information, contact Adam Equipment or your supplier.



## 17.1 TROUBLE-SHOOTING GUIDE.

<b>BALANCE DOES NOT FUNCTION</b>		
<b>Problems</b>	<b>Possible causes</b>	<b>Suggestions</b>
The balance is dead when power is applied	Power supply failure	Check adapter is working Check adapter is correct for the balance Normal adapter is 18VDC, 830mA. *Power supply circuit board failure *Short circuit on any circuit board
The display does not turn on but the calibration motor moves when power is applied	Power is getting to balance, display is not working	*Display cables may be faulty *Display module failure
The display stays on the initial test screen when power is applied. Calibration weight motor is on.	Unstable balance Balance not working correct Power supply	*Check if balance is stable by using service menu and view A/D values Put draught shield over pan Check power supplies
<b>BALANCE WORKS BUT IS NOT STABLE</b>		
Balance is unstable by a few divisions	Noise or vibration from environment Friction in mechanics	Check the balance is positioned correctly to avoid vibration, wind or air movement, it is on a solid table, It is not near sources of heat or cool air, Check balance with weights if problem occurs when sample is used. Static electricity on the samples can cause drifting and instability. Check the area around the weighing pan for hair, dust, obstructions under the pan, *A complete inspection of the mechanics to look for sources of friction may be needed.
Balance is very unstable and does not weigh correctly	Mechanical problems  Balance programming  Electronic problems	*A complete inspection of the mechanics to look for sources of friction. *Verify the A/D is also unstable. If the A/D is OK then suspect the programming of the balance. Reset parameters, check linearity and redo the calibration. Some electronic problems can also cause this. But all mechanical problems must be resolved first.
<b>BALANCE IS NOT ACCURATE</b>		
You must have accurate and trusted weights to test a balance. If you suspect that the balance is not accurate then you must know your weights are accurate. A balance calibrated using a bag of flour is not accurate even if it works OK otherwise.		
Balance is not accurate	Repeatability  Eccentric loading  Linearity	Verify the balance shows the same value when the same mass is placed on the centre of the pan for a few tests. Verify the balance shows the same reading (within a tolerance depending upon the model) when a mass is placed at positions around the pan. Verify the balance is acceptable throughout the weighing range. The balance must give acceptable readings from low weights up to the capacity.

Poor Repeatability	Usually a mechanical problem.	Inspect the area around the pan for hair, dust or other obstructions, *Inspection of the mechanics may be needed for any possible problems.
Poor Eccentric Loading	A mechanical problem	Inspect the area around the pan for hair, dust or other obstructions.
Poor Linearity	Usually a mechanical problem  Electronic Problems	Re-check repeatability *Inspection of the flexures for damage or loose hardware may be required *Use the Linearity Function in the service menu to reset linearity *A problem in the analogue circuit board or power supplies can cause poor linearity. Make sure all mechanical problems have been eliminated first
<b>OTHER PROBLEMS:</b>		
Cannot calibrate	Zero shifted more than allowed  Calibration timeout	*Check all flexures for damage *Reset dealer calibration *Verify linearity and repeatability *The balance may be unstable. Verify stability as above.
Calibration weight motor does not stop		*Check the cables to the motor, try plugging the balance into the power again *Look for friction in the calibration weight movement *Check the opto-coupler that controls the motor position.
USB / RS-232 not working	Doesn't print	Check parameters match the device connected Verify cable is correct *RS-232 circuits damaged
Display dark, keys beep	Display contrast poor Cable unplugged or damaged	*Check the cables to the display *Replace the display which could be damaged

\*To be carried out by authorised technicians only.

## 18.0 SERVICE INFORMATION

This manual covers the details of operation. If you have a problem with the balance that is not directly addressed by this manual then contact your supplier for assistance. In order to provide further assistance, the supplier will need the following information which should be kept ready:

### **A. Details of your company**

- Name of your company:
- Contact person's name:
- Contact telephone, e-mail,
- Fax or any other methods:

### **B. Details of the unit purchased**

(This part of information should always be available for any future correspondence. We suggest you to fill in this form as soon as the unit is received and keep a print-out in your record for ready reference.)

<b>Model name of the balance:</b>	Luna _____
<b>Serial number of the unit:</b>	
<b>Software revision number (Displayed when power is first turned on):</b>	
<b>Date of Purchase:</b>	
<b>Name of the supplier and place:</b>	

### **C. Brief description of the problem**

Include any recent history of the unit. For example:

- Has it been working since it was delivered?
- Has it been in contact with water/liquid/particles?
- Damaged from a fire?
- Electrical Storms in the area?
- Dropped on the floor, etc.?

# 19.0 BALANCE MENU STRUCTURE

## Operator Level Access

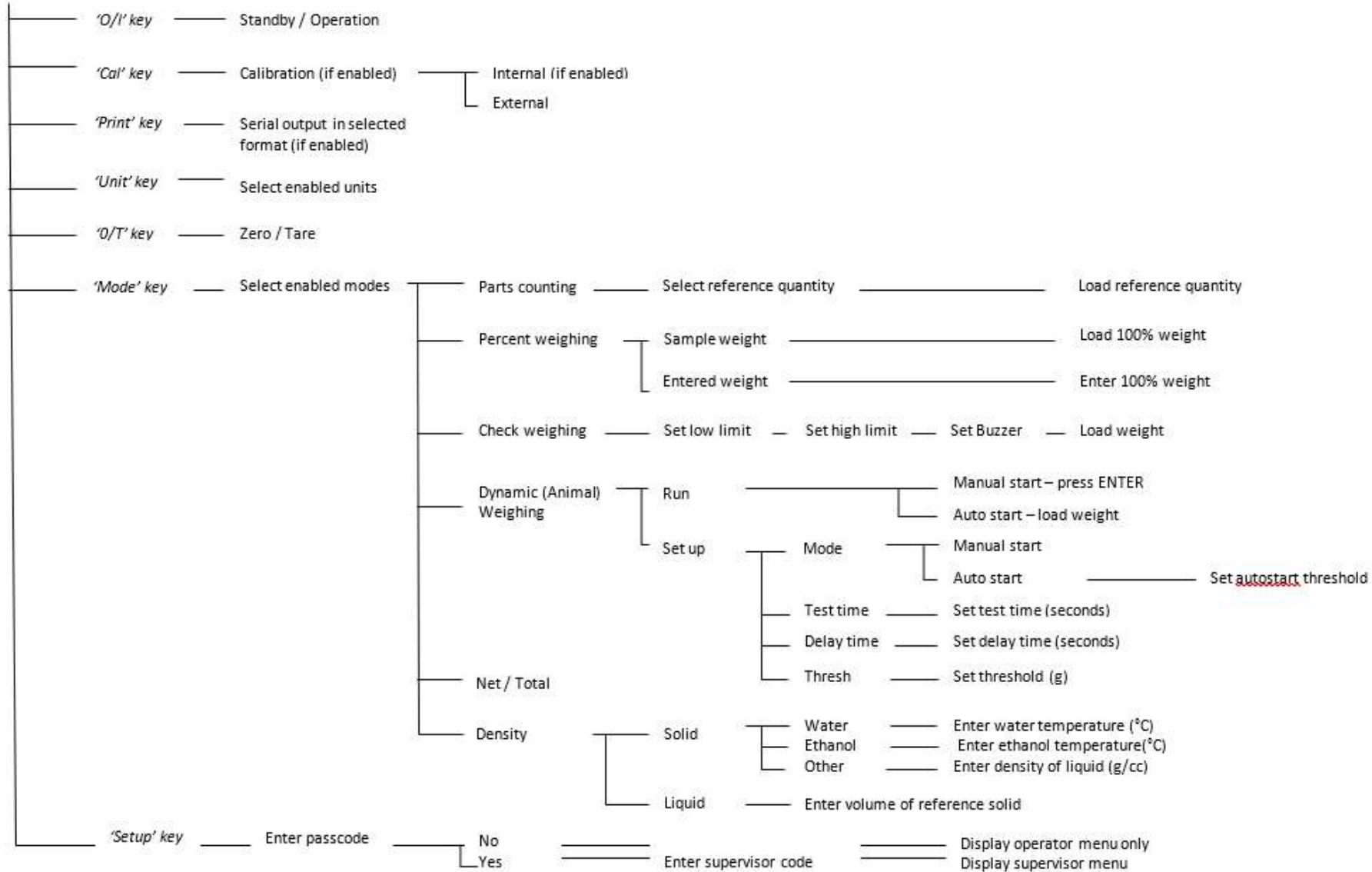

## LUNA OPERATING SOFTWARE MENU STRUCTURE

## Supervisor Level Access

**Note:** Some menu options are not available, or extra options may be visible depending on if the model is internal or external calibration type, and whether it is an approved model. Conditions of approval in some countries necessitates adding or removing some options from the user interface.

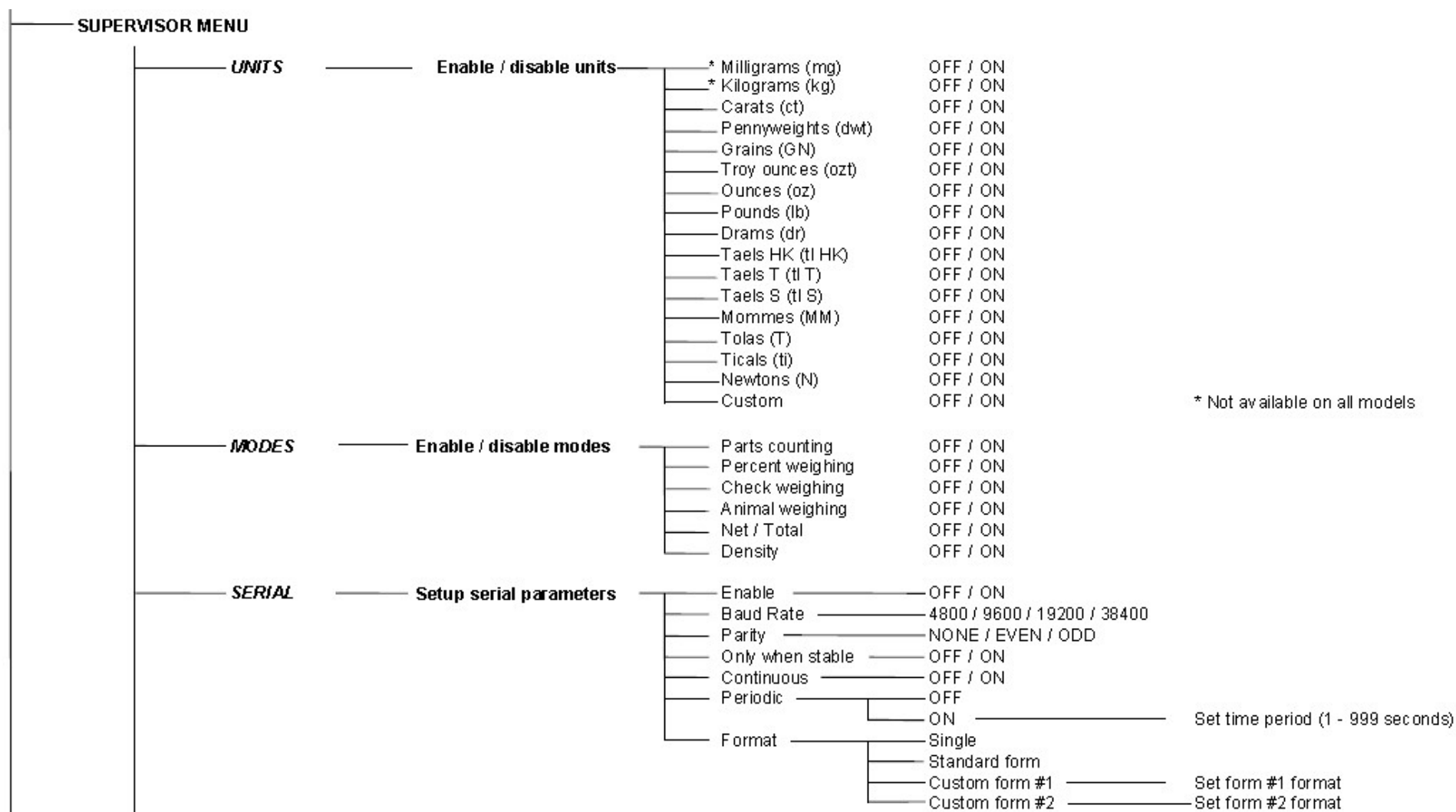

## Supervisor Level Access (continued)

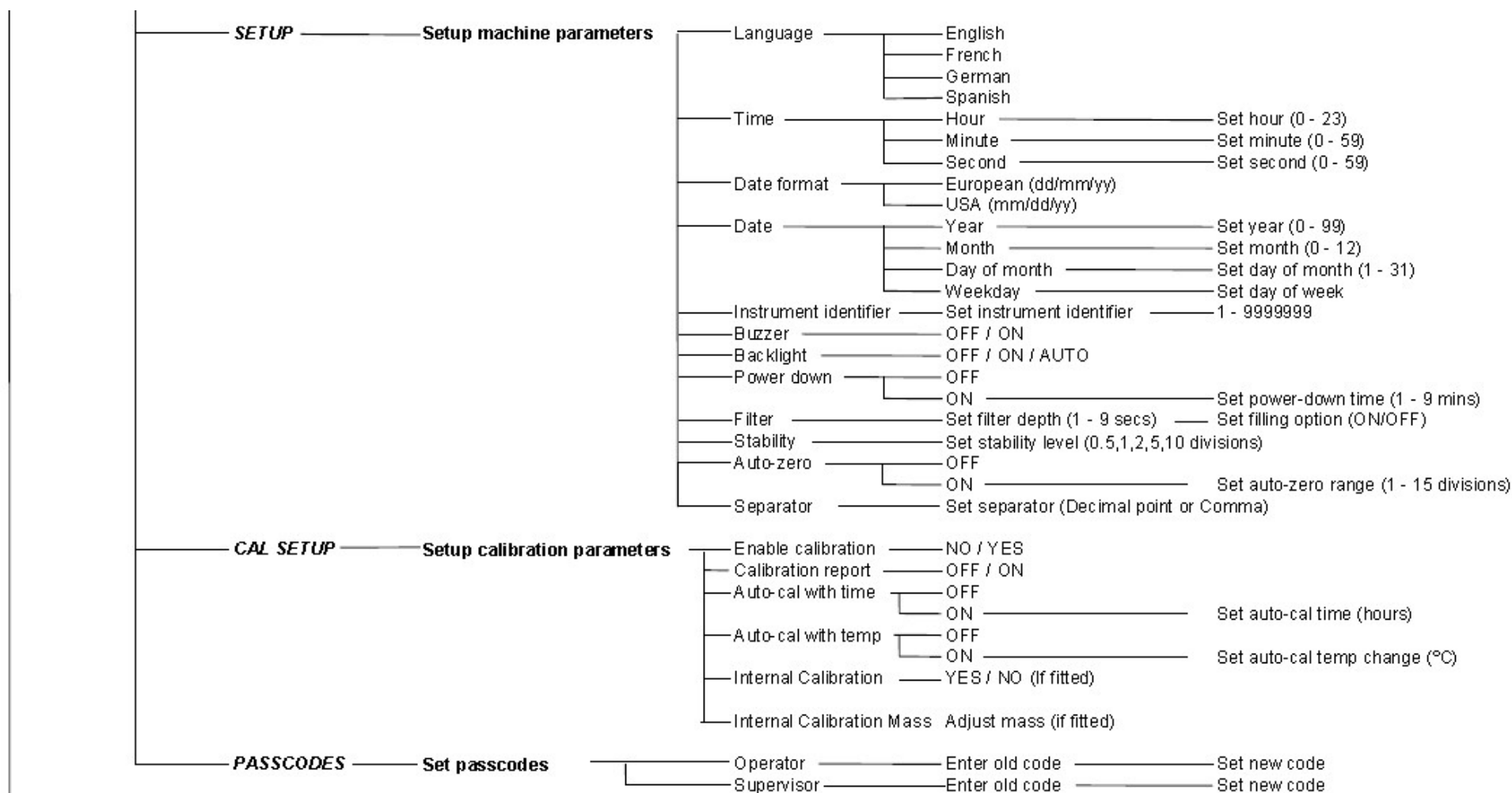

## 20.0 LANGUAGE TABLE

If language is changed, the menu text shown during many operations will change. This table shows many of the translations used.

English	Spanish	German	French	Function	English	Spanish	German	French	Function
Auto-Zero	Aut0-ZE	Aut0-ZE	Aut0-ZE	Auto-Zero	LANGUAG	LENGUA	SPRACHE	LANGUE	Language
Stability	EstAbiLi	StAb-t0	StAbiLi	Stability	ENGLI SH	INGLESES	ENGLI SH	ANGLAIS	English
Filter	FiLteR	FiLteR	FiLteR	Filter	SPANI SH	ESPAÑOL	SPANI SH	ESPAGNOL	Spanish
Power	POWEr	EnErG A	AUSSCHA	il SE HS	9ERiitAn	ALeiAn	dEuTSCH	ALLiind	German
Backlight	bACHLi t	CDntrAL	Hi nteEr9	ECLAI rA	FrEnCH	FrAnCES	FrAn2OE	FrnCAI S	French
Buzzer	buZZEr	ZuñbAd0	SuññEr	ALARñE	dATE	FECHA	dAteuñ	dATE	Date
Instrument ID	Inst Id	Id Inst	InstEr-1	IdEnt 1	dAt tHu	FEC JuE	dAt dOn	dAt uEu	Day <day>
Calibration Setup	CAL SEt	di SP CA	HAL EI n	rE9LEr	YEAr	An0	JAHr	AnnEE	Year
Setup	SEtUP	di SPOSI	Ei nStLL	rE9LAGE	ñDntH	ñES	ñDnAt	ñOI S	Month
Serial Setup	SErIAL	SErIAL	SErIE P	SEr iE	dAY	di A	tAG	uDur	Day
Modes	ñODES	ñODOS	ñODuS	ñodes	tHursdA	JuEuES	dOnnErS	uEudl	Thursday
Units	uni tS	uni dAdE	Ei nHEi t	un itES	FrI dAY	ul ErnES	FrEI tAG	uEndrEd	Friday
Passcode	PASSCOd	CDntrAS	PASSñOr	COdes	StAturdA	SABAd0	SATStAG	SATEdi	Staturday
Operator mode	PC OPEr	OPErAd0	OPErAt0	OPErAtE	SundAY	dOnl n90	SOnntAG	di ñAnCH	Sunday
Supervisor mode	Pc SuPE	SuPERul	l nSPEHt	SuPERul	ñDndAY	LunES	ñDntAG	Lundl	Monday
On	On	En	An	On	tUESdAY	ñArtES	di EnStA	ñAr dl	Tuesday
Off	OFF	dE	AuS	OFF	ñEdnESd	ñErCOl	ñi tEtñOC	ñErCrEd	Wednesday
Enable	EnAbLE	PErñi t	ErñO9L	ACti uE	dAtE FOR	FORñ FE	dAteuñ-F	Forñ dA	Date format
Yes	YES	SI	JA	Oui	EUR0PE	EUR0PA	EUR0PA	EUR0PE	European (DD:MM:YY)
No	n0	n0	nEI n	n0n	uSA	ATñErI CA	ATñErI HA	uSA	USA (MM:DD:YY)
Internal Mass Calibration	Int ñAS	ñASA l n	Int ñAS	ñASSE l	tI ñE	tI EiñPO	uHr2Ei t	HEurE	Time
Internal Calibration	Int CAL	CAL Int	IntErn	PdS CAL	H0ur	H0rA	Stunde	HEurE	Hours
Temperature Calibration	tEñ CAL	CAL tEñ	tEñP-HA	CAL tEñ	ñi nute	ñi nute0	ñi nute	ñi nute	Minutes
Timed Calibration	tI ñ CAL	CAL tIE	2Ei t-HA	CAL tPS	SECOnd	SE9und0	SEHunde	SECOndE	Seconds
Calibration Report	CAL rEP	l nFORñ	HAL-rEP	rAPPOR					

## 21.0 WARRANTY INFORMATION

Adam Equipment offers Limited Warranty (Parts and Labour) for any components that fail due to defects in materials or workmanship. Warranty starts from the date of delivery.

During the warranty period, should any repairs be necessary, the purchaser must inform its supplier or Adam Equipment. The company or its authorised technician reserves the right to repair or replace the components at the purchaser's site or any of its workshops depending on the severity of the problems at no additional cost. However, any freight involved in sending the faulty units or parts to the service centre will be borne by the purchaser.

The warranty will cease to operate if the equipment is not returned in the original packaging and with correct documentation for a claim to be processed. All claims are at the sole discretion of Adam Equipment.

This warranty does not cover equipment where defects or poor performance is due to misuse, accidental damage, exposure to radioactive or corrosive materials, negligence, faulty installation, unauthorised modifications or attempted repair or failure to observe the requirements and recommendations as given in this User Manual.

This product may include a rechargeable battery that is designed to be removed and replaced by the user. Adam Equipment warrants that it will provide a replacement battery if the battery manifests a defect in materials or workmanship during the initial period of use of the product in which the battery is installed.

As with all batteries, the maximum capacity of any battery included in the product will decrease with time or use, and battery cycle life will vary depending on product model, configuration, features, use, and power management settings. A decrease in maximum battery capacity or battery cycle life is not a defect in materials or workmanship, and is not covered by this Limited Warranty.

Repair carried out under the warranty does not extend the warranty period. Components removed during the warranty repairs become the company property.

The statutory rights of the purchaser are not affected by this warranty. In the event of dispute then the terms of this warranty are governed by UK law. For complete details on Warranty Information, see the terms and conditions of sale available on our web-site.





## WEEE 2012/19/EU

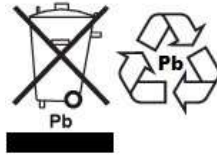

This device may not be disposed of in domestic waste. This also applies to countries outside the EU, per their specific requirements. Disposal of batteries (if fitted) must conform to local laws and restrictions.

Cet appareil ne peut être éliminé avec les déchets ménagers. L'élimination de la batterie doit être effectuée conformément aux lois et restrictions locales.

Dieses Gerät nicht mit dem Hausmüll entsorgt.

Dispositivo no puede ser desechado junto con los residuos domésticos

Dispositivo non può essere smaltito nei rifiuti domestici.

## FCC / IC CLASS A DIGITAL DEVICE EMC VERIFICATION STATEMENT

NOTE: This equipment has been tested and found to comply with the limits for a Class A digital device, pursuant to Part 15 of the FCC rules and Canadian ICES-003/NMB-003 regulation. These limits are designed to provide reasonable protection against harmful interference when the equipment is operated in a commercial environment. This equipment generates, uses and can radiate radio frequency energy and, if not installed and used in accordance with the instruction manual, may cause harmful interference to radio communications. Operation of this equipment in a residential area is likely to cause harmful interference in which case the user will be required to correct the interference at his own expense.

## CALIFORNIA PROPOSITION 65 - MANDATORY STATEMENT

WARNING: This product includes a sealed lead-acid battery which contains chemicals known to the State of California to cause cancer and birth defects or other reproductive harm.



Adam Equipment products have been tested with, and are always supplied with mains power adaptors which meet all legal requirements for the intended country or region of operation, including electrical safety, interference and energy efficiency. As we often update adaptor products to meet changing legislation it is not possible to refer to the exact model in this manual. Please contact us if you need specifications or safety information for your particular item. Do not attempt to connect or use an adaptor not supplied by us.

**ADAM EQUIPMENT** is an ISO 9001:2015 certified global company with more than 40 years' experience in the production and sale of electronic weighing equipment.

Adam products are predominantly designed for the Laboratory, Educational, Health and Fitness, Retail and Industrial Segments. The product range can be described as follows:

- Analytical and Precision Laboratory Balances
- Compact and Portable Balances
- High Capacity Balances
- Moisture analysers / balances
- Mechanical Scales
- Counting Scales
- Digital Weighing/Check-weighing Scales
- High performance Platform Scales
- Crane scales
- Mechanical and Digital Electronic Health and Fitness Scales
- Retail Scales for Price computing

For a complete listing of all Adam products visit our website at  
[www.adamequipment.com](http://www.adamequipment.com)

<p><b>Adam Equipment Co. Ltd.</b>  Maidstone Road, Kingston  Milton Keynes  MK10 0BD  UK  Phone: +44 (0)1908 274545  <b>e-mail:</b>  <a href="mailto:sales@adamequipment.co.uk">sales@adamequipment.co.uk</a></p>	<p><b>Adam Equipment Inc.</b>  1, Fox Hollow Rd.  Oxford, CT  06478  USA  Phone: +1 203 790 4774  <b>e-mail:</b>  <a href="mailto:sales@adamequipment.com">sales@adamequipment.com</a></p>	<p><b>AE Adam GmbH.</b>  Instenkamp 4  D-24242 Felde   Germany  Phone +49 (0)4340 40300 0  <b>e-mail:</b>  <a href="mailto:vertrieb@eadam.de">vertrieb@eadam.de</a></p>
<p><b>Adam Equipment S.A. (Pty) Ltd.</b>  7 Megawatt Road,  Spartan EXT 22  Kempton Park,  Johannesburg,  Republic of South Africa   Phone +27 (0)11 974 9745  <b>e-mail:</b>  <a href="mailto:sales@adamequipment.co.za">sales@adamequipment.co.za</a></p>	<p><b>Adam Equipment (S.E. ASIA) PTY Ltd</b>  70 Miguel Road  Bibra Lake  Perth  WA 6163  Australia   Phone: +61 (0) 8 6461 6236  <b>e-mail:</b>  <a href="mailto:sales@adamequipment.com.au">sales@adamequipment.com.au</a></p>	<p><b>Adam Equipment (Wuhan) Co. Ltd.</b>  Building E, East Area,  Private Industrial Park, Wuhan EDZ,  Zhuanyang Avenue,  Hubei Province 430056  P.R.China   Phone: + 86 (27) 59420391  <b>e-mail:</b>  <a href="mailto:info@adamequipment.com.cn">info@adamequipment.com.cn</a></p>

© Copyright by Adam Equipment Co. All rights reserved. No part of this publication may be reprinted or translated in any form or by any means without the prior permission of Adam Equipment.

Adam Equipment reserves the right to make changes to the technology, features, specifications and design of the equipment without notice.

All information contained within this publication is to the best of our knowledge timely, complete and accurate when issued. However, we are not responsible for misinterpretations which may result from the reading of this material.

The latest version of this publication can be found on our Website.

[www.adamequipment.com](http://www.adamequipment.com)